



FAMO: WORKING TOGETHER
COMPANY PRESENTATION 2023

FAMO: WORKING TOGETHER

[ABOUT US](#) | [PRODUCTS](#) | [PROJECTS](#)

Every day a lot of ideas arise...
But only a few have the power to change everything.



HISTORY

One idea can change everything.

In 76 years, one idea became one of the most ambitious projects in the Portuguese office furniture industry. On **14 August 1947**, **Mr. Jaime Pinto de Moura** founded FAMO.

FAMO – Steel Office Furniture – a new project, with a new implicit concept of quality. A new approach based on creativity and experience.

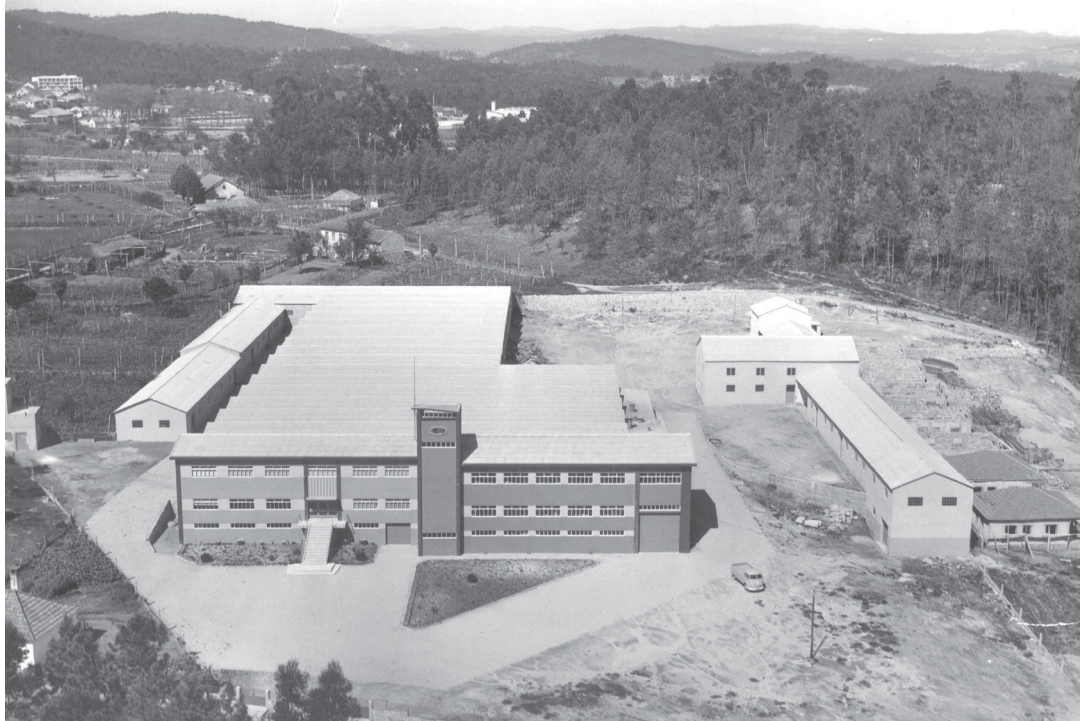

CHRONOLOGY

HISTÓRIA DA FAMO

PRINCIPAIS MARCOS

1973

Constituição da sociedade sob a designação de JAIME PINTO DE MOURA, FILHOS & Cª, LDA.

1998

Alteração da designação social para FAMO – Indústria de Mobiliário de Escritório, Lda.

2000

Obtenção da Certificação segundo o referencial normativo NP EN ISO 9001:1995

2010

Obtenção da Certificação do Sistema de Gestão Ambiental da empresa segundo o referencial normativo NP EN ISO 14001:2004

2014

Obtenção da Certificação PEFC ST 2002:2013: Cadeia de Responsabilidade de Produtos de Base Florestal
Obtenção das Certificação FSC-STD-40-004: Certificação Cadeia de Responsabilidade

2017

Investimento numa nova unidade fabril em Lordelo, Paredes

2018

Obtenção da Indoor Advantage™ GOLD

2019

Obtenção da certificação de produtos da linha ECO de acordo com a norma NF EN 527; NF EN 14073

2020

Obtenção do Certificado de Registo da Marca NANOSAFE na U.E., Nº18244421



Lousada

First unit



Lordelo

Equipped with 1 485 solar panels.
100% autonomy of production, on sunny days.



Castalla

Collaborating with Dile

MANAGEMENT POLICY

Customers and markets

Listening to our people, identifying and advancing their needs, satisfying and exceeding expectations.

Quality and Organization

Fulfilment of management system procedures, of the requirements applying to our activity (customer, statutory and legal) and guiding organizational strategies with a perspective of continuous improvement, by regularly reviewing processes, policy, goals and targets.

Environment

We are conscious that in small details we can contribute to improve quality of life to current and future generations, in direction of social and environmental responsibility. That takes us to assume a serious environmental commitment and pollution prevention. Following this view, the strict compliance of standards established by our company, goes beyond the simple compliance of legal requirement.

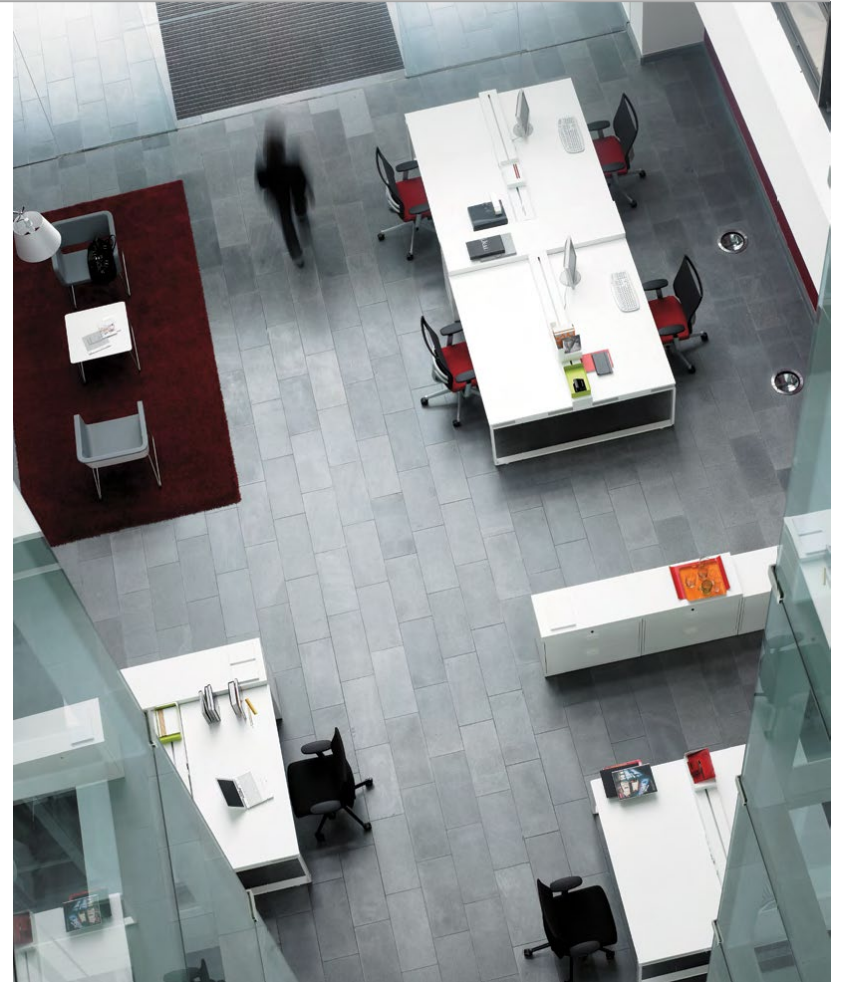

MANAGEMENT POLICY

Technology and Innovation

We bet on technological improvement and updating in the organization, as well as increasing the level of products/ services innovation according to tendencies and necessities of different markets.

Association

Stimulate the growth, commitment and motivation amongst all collaborators and distributors, to get involved in the day by day of company goals and targets; provide commitment relations with all the stakeholders, based on a spirit permanent collaboration to promote supplying of better information, goods and services.

Results

To increase productivity and quality levels, guarantee adequate management strategies, to increase the profit of the company and supply funds to growth through the reinvestment.



CERTIFICATES

Quality and environment management system



Quality Management System



Environmental Management System



Forests for All Forever



Programme for the Endorsement of Forest Certification



Reliable Energy Systems



Ecodesign Management

OUR COMPROMISE WITH QUALITY AND ENVIRONMENT

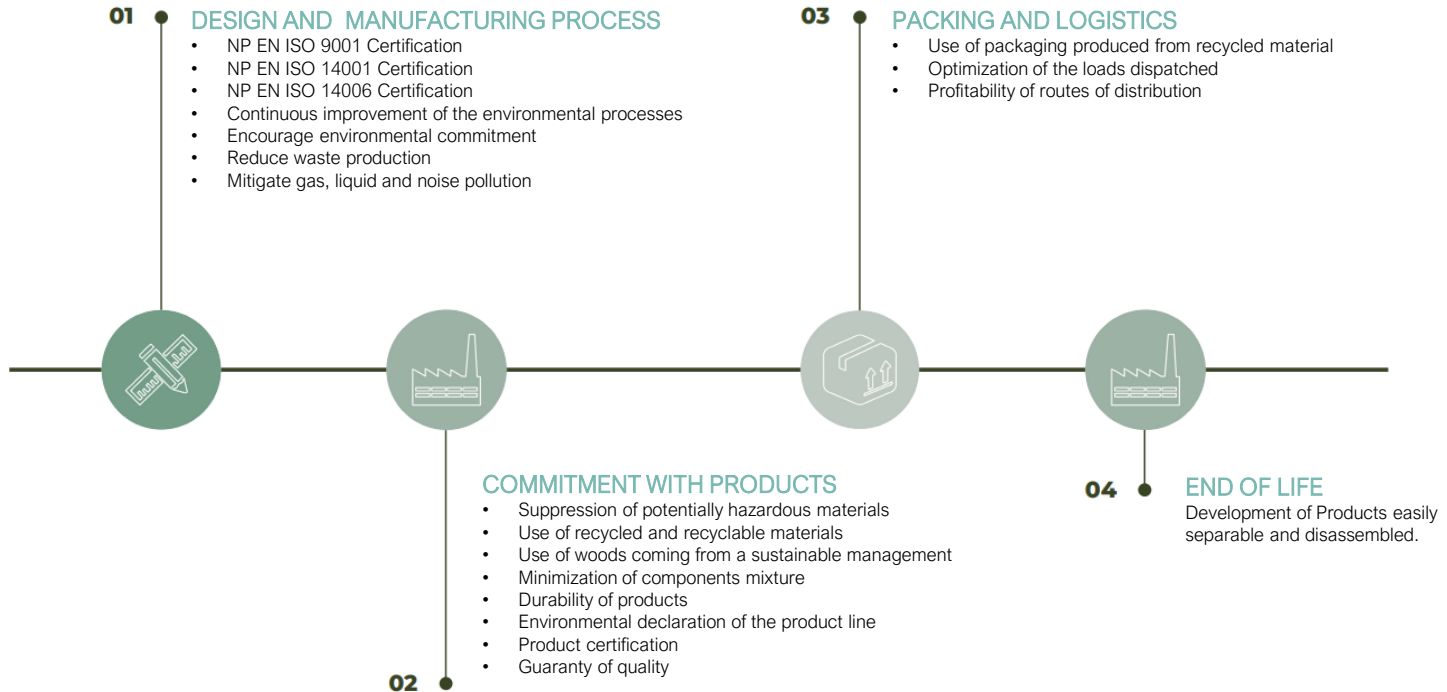

APPROACHES



DESIGN



INDUSTRIAL CRAFTSMAN



ASSEMBLY SERVICES

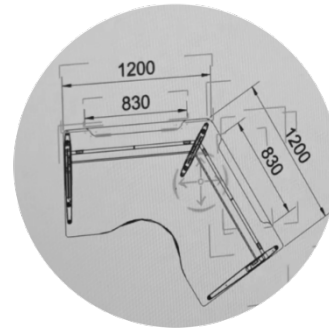

FLEXIBILITY



SUPPLY CHAIN

WORKERS



FAMO TEAM 305



AROUND THE WORLD

The growth of FAMO is the best proof of commitment with our values. FAMO is a company with international dimension and continuous expansion. With headquarters in Portugal, we are present in **43 countries** of 4 continents.



OUR SHOWROOMS

Headquarters

PORTUGAL

LOUSADA
 FAMO - Ind. Mobiliário Escritório, Lda.
 Rua 1º de Maio, nº112 . 4620-131
 Lousada
 Tel. +351 255 810 580
 Fax +351 255 810 589
 lousada@famo.pt

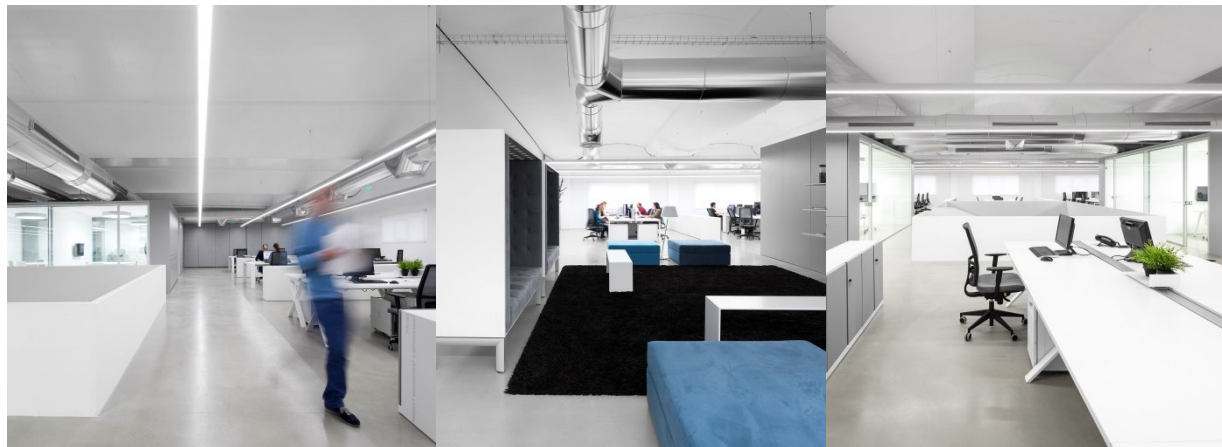

Delegations

PORTUGAL

Showroom/Unit 2
 Rua da Zona Industrial nº330
 4580-565 Lordelo
 Tel. +351 255 244 980
 porto@famo.pt

PORTUGAL

Showroom
 Rua Padre Américo, 2-B
 1600-548 Lisboa
 Tel. +351 217 102 540
 Fax +351 255 810 589
 lisboa@famo.pt

SPAIN

Showroom
 Calle Conde de Aranda,
 nº22, bajo Izq. 28001 Madrid
 Tel. +34 682 771 271

SPAIN

Showroom
 C/Alaba Nº 61,
 4ª-3ª 08005, Barcelona
 Tel. +34 699 894 033

FRANCE

LBC, Le showroom
 by "Le Bureau
 Contemporain"
 Rue Réaumur nº115 .
 75002 Paris
 Tel. +33 1 40 15 08 13

ANGOLA

Showroom
 Rua Cirilo Conceição Silva,
 Nº8-B . LUANDA
 Tel. +244 222 339 963
 Tel. +244 947 499 628
 Fax +244 222 331 713
 luanda@famo.pt

DUBAI

Showroom
 Famo Trading LLC
 Sheikh Zayed Rd. Aswar Bidg,
 Office n.111, Al Wasl Area.
 Dubai – United Arab Emirates
 P.O. BOX 74947
 Tel. +97 143 325 623

FAMO: WORKING TOGETHER

ABOUT US | **PRODUCTS** | PROJECTS

More than single pieces of furniture, FAMO develops innovative solutions for specific workspaces.



TIMELINE

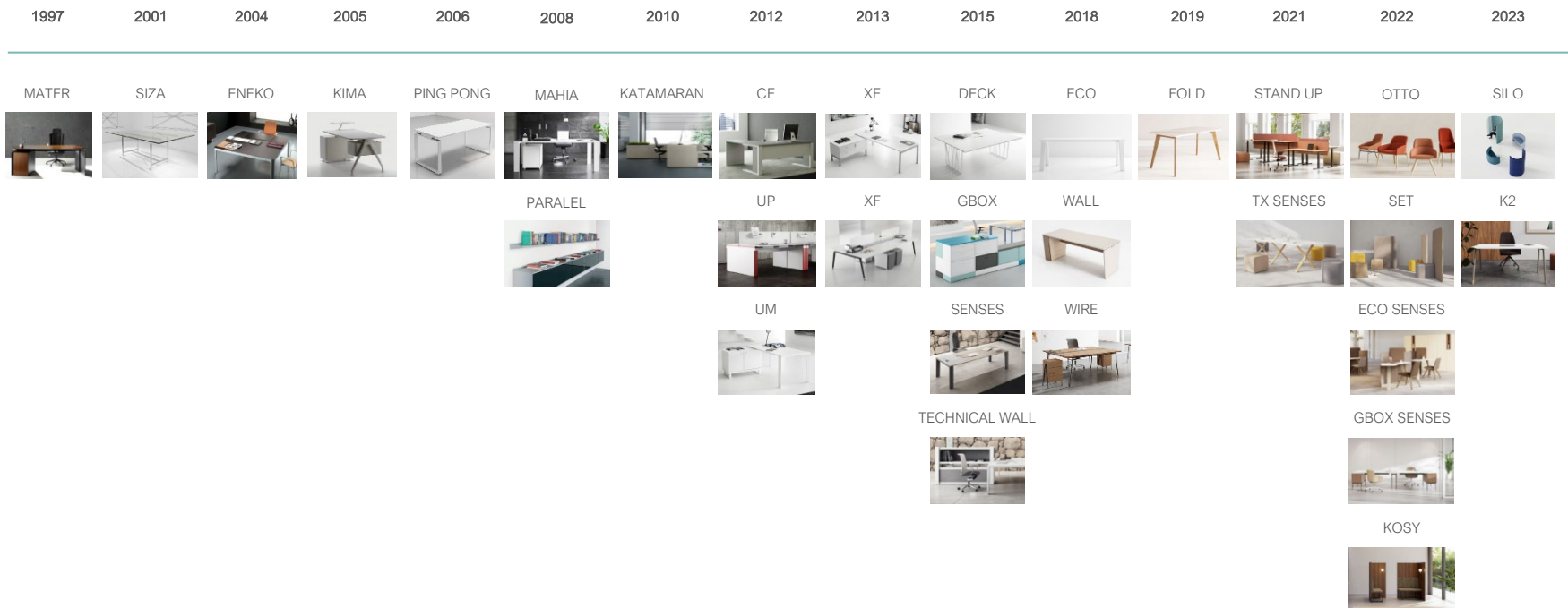

OPERATIVE

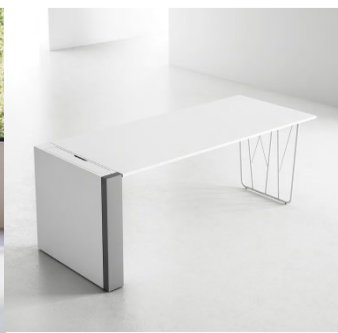

WORKSTATION

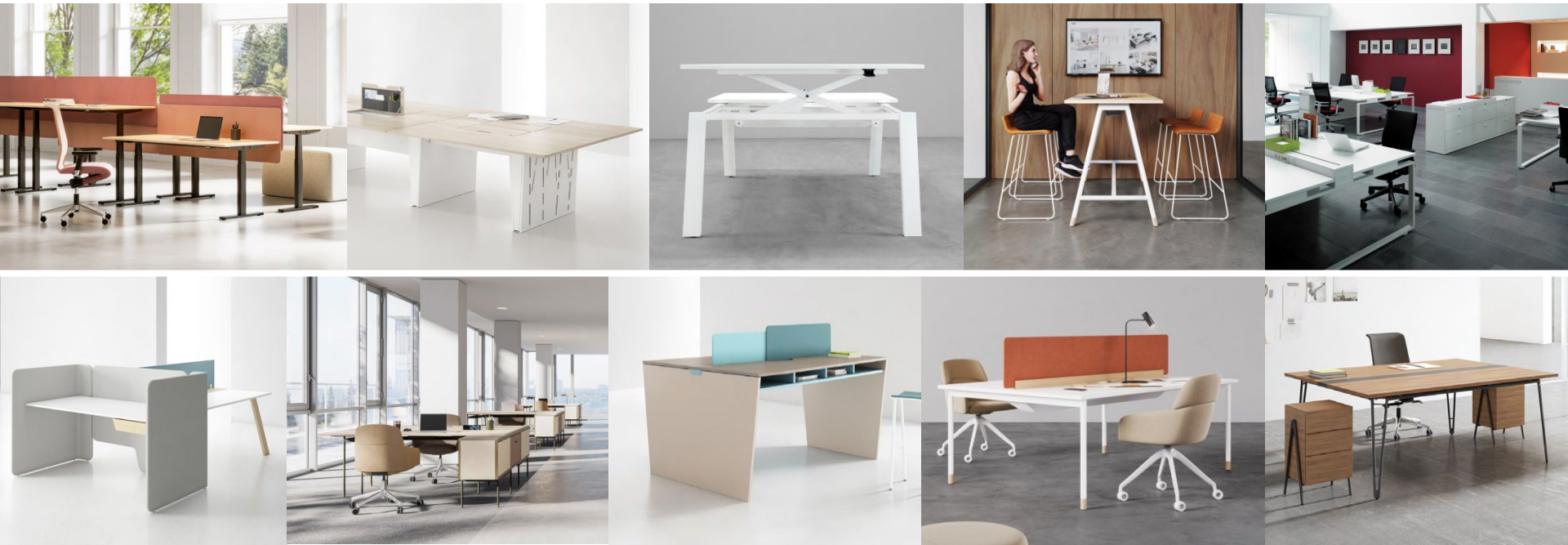

EXECUTIVE



CONFERENCE



RECEPTION

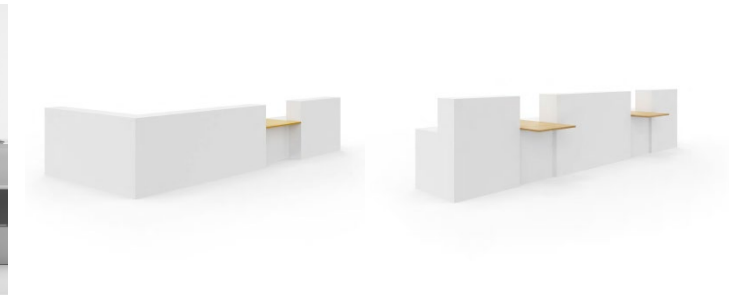

BOOTH



STORAGE



SEATING



LOUNGE SEATING



ACCESSORIES

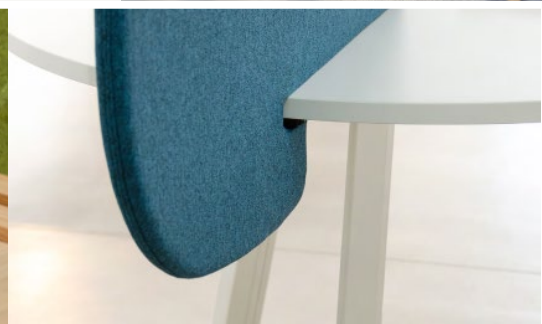
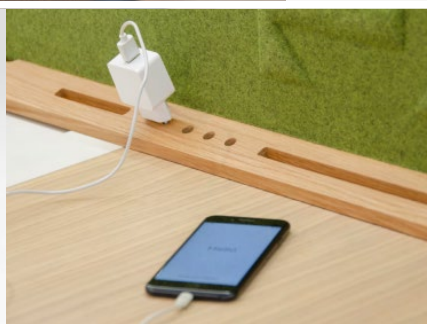
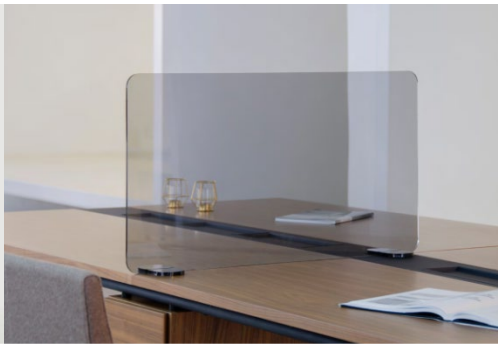

FAMO: WORKING TOGETHER

ABOUT US | PRODUCTS | **PROJECTS**

The FAMO projects department provides space planning services, implementing in 3D the chosen product line, making its framework on the space to be occupied or reshaped more perceptibly. In “turn-key” projects, our projects department analyses and studies the most appropriate solutions regarding the space creation of functional offices, with a modern environment and adapted to the client’s image.



WAXMAN

Israel | 2023



ALBIOMA

France | 2023



MUIEL ANGEL

Spain | 2023



ALPIQ

France | 2023



SCF GROUP

Israel | 2022



UCI

Portugal | 2022



RECTO VERSO 139

Spain | 2022



ORSHAY

Israel | 2022



TJA

Portugal | 2022



ROBERT FONDATION

France | 2022



IM ASSOCIATES

Netherlands | 2021



VAN DIJK GROEP

Netherlands | 2021



FAMO: WORKING TOGETHER
SINCE 1947

WWW.FAMO.PT





THANK YOU

FAMO: WORKING TOGETHER